

PERSONALISED PRODUCTS

CATALOGUE



ArDOS · Archirrado · ArchivoTec Series 4000 · Display Boards · Signs · Archicubo · Countertop Brochure Holders · Countertop Nameplate Holders · Countertop T-shaped and L-shaped Sign Holders · Rotating Countertop Sign Holders · Curved Countertop Sign Holders · Bevelled Countertop Sign Holders · Multi-sided Sign Holders · Countertop Menu Holders · Countertop Lecterns and Desk Stands · Cardholder Displays · Suggestion and Ballot Boxes · Multi-purpose Wall-mounted Display Cases · Retail Store Displays · Posterfix · Stackable Trays · Jumborack · Filing Boxes · Waste Paper Bins and Umbrella stands · Archibox · Storage · Box Organisers · Tube-Shaped Containers · Flexitub · Clip Holders · Desk Calendar Holders · Pencil Holders · Desktop Organisers · Desktop Memo Holders · Coin Holders

www.archivo2000.com

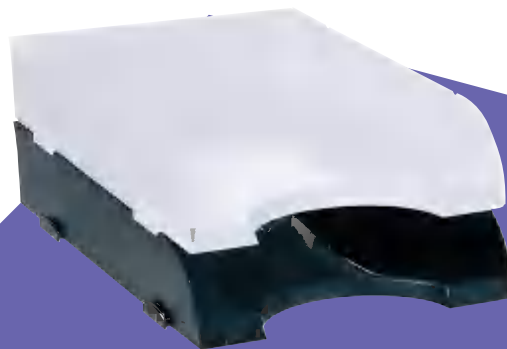

Personalised Products

Completely Customised!

- > We manufacture all our products in Spain by means of injection and stretch-blow-moulding processes and using top-quality materials.
- > We hold both the Manufacturing ISO 9001 Certification and also the ISO 14001 Environmental Certificate.
- > We are the top-leading firm of our sector in Spain dedicated to the manufacturing of Office Accessories in Injected Plastic.
- > We offer our clients the best quality-price ratio in all our range of products, offering the maximum flexibility regarding manufacturing and delivery times.
- > We cover all our clients' special production needs as far as production and customising products.

We adapt to your needs!



archivo[®]
2000

We manufacture high-quality
custom-made products

Plastic Injection

All types of plastic products, with different finishings and in a wide variety of colours.



Containers

We manufacture containers of up to 1 litre of capacity in many colours and finishes.



Our File Section

Riveting machines and presses to work on cold-rolled plates which combined with the injection of parts result in sturdy and functional files.



Other processes...

Ultrasonic welding, thermo bonding, tampon printing, serigraphy, thermal printing, IML...



Filing and Classifying

Ardos 5
 Archirrado 6



Archicubo

Archicubo..... 9



Modular System Files

ArchivoTec Series 4000..... 6

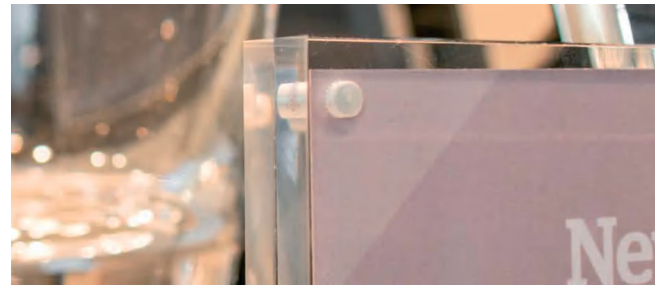

Display Cases

Display Brochure Holders with one
 or several pockets 10
 Name Holders 11
 Slanted Sign Holders 12
 Stand - up Sign Holders 14
 Swivel Sign Holders 16
 Curved Magnetic Sign Holders 16
 Bevelled Edge Slanted Sign Holders 16
 Multi-sided Sign Holders..... 16
 Menu Holders..... 17
 Book / Diary Stand..... 17
 Card Holder Displays 17
 Suggestion and Ballot Boxes 18
 Wall-mounted Display Cases (with adhesive) 19
 Wall-mounted Display Cases (with drilled holes)..... 19
 Wall-mounted Brochure Holders (1 pocket)..... 20
 Retail Store Displays (Magnetic Acrylic Blocks)..... 20

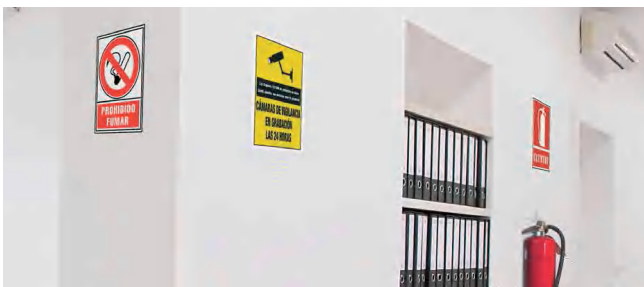

Signage Elements

Signs..... 7

INDEX



Letter Trays

Stackable Trays.....	21
Jumborack	23



In Order

Archibox.....	28
Storage.....	28
Box Organisers.....	33
Tube-Shaped Containers.....	34



Filing Boxes

Filing Boxes	25
--------------------	----



Office Accesories

Desk Calendar Holders	35
Pencil Cups.....	36
Desktop Organisers	38
Desktop Memo Holders.....	38
Coin Banks.....	40



Waste Paper Bins and Umbrella Stands

Plastic Waste Paper Bins	26
Umbrella Stands and Floor Ashtrays.....	27



Our high-capacity line of sturdy, light and functional files



- Files manufactured with painted steel spine and with interchangeable identification tab holder with label of 54 x 64 mm and with thumb hole.
- Covers are made with reinforced cardboard and come with plastic-injected corner pieces.
- Its exclusive mechanism with a 3-positional fastening system permits you to photocopy or consult documents without having to remove them. Easy-to-use lever to secure and release documents.



REF. 384AP



- 80x80x80 mm ring spacing.
- 4 half rings.
- 60 mm spine
- Covers measure: 240x315 mm

COLOURS:

384AP GREY	384AP GREEN
384AP BLUE	384AP YELLOW
384AP BLACK	384AP RED
384AP WHITE	

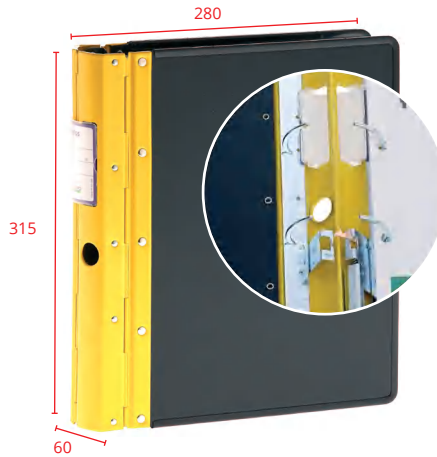

REF. 384AR



- 80x80x80 mm ring spacing.
- 4 complete rings.
- 60 mm spine
- Covers measure: 240x315 mm

COLOURS:

384AR GREY	384AR GREEN
384AR BLUE	384AR YELLOW
384AR BLACK	384AR RED
384AR WHITE	

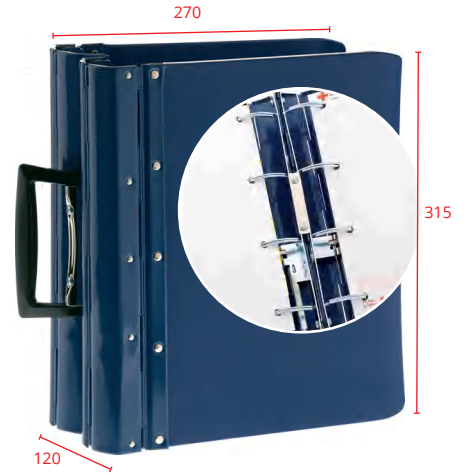

REF. 384AP2L



- 80x80x80 ring spacing. 4 half rings per spine. File with spine and double handle.
- 120 mm spine
- Covers measure: 240x315 mm

COLOURS:

384AP2L GREY	384AP2L GREEN
384AP2L BLUE	384AP2L YELLOW
384AP2L BLACK	384AP2L RED
384AP2L WHITE	

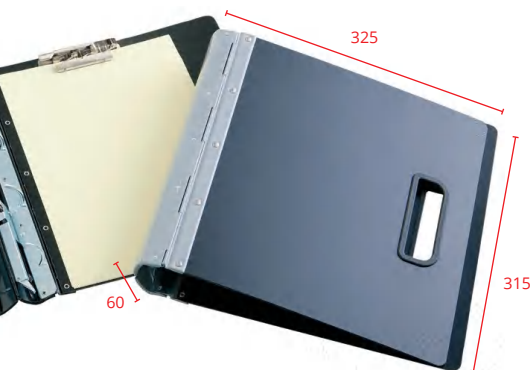

REF. 384APCA5



- 80x80x80 mm ring spacing. 4 half rings.
- 60 mm spine. Cover-handles and miniclip in rear side.
- Covers measure: 285x315 mm

COLOURS:

384APCA5 GREY	384APCA5 GREEN
384APCA5 BLUE	384APCA5 RED
384APCA5 BLACK	384APCA5 WHITE
384APCA5 YELLOW	



CUSTOM-MADE AND PERSONALISED

- Apart from the standard models, the ARDOS model can be manufactured in any size or colour, with double or single spine and handles (briefcase).
- The double-spine file of 120mm can hold up to 1000 sheets or 500 plastic classifying pockets.
- Handles can be attached to spine or covers making its handling and transport easy.
- Ideal as sample catalogues with a great number of references.
- Personalised covers by means of serigraphy or thermal printing.

Plastic File Rado System for DIN A4 formats.

- File with lever mechanism injected in unbreakable polypropylene copolymer.
- Lever mechanism with 80 mm ring spacing (2 rings) with compressor bar which permits documents to be removed all at once and be placed in archived cases. Translucent colours.



REF. 210 TL

- 80 mm ring spacing (2 rings) with compressor bar.
- 70 mm spine. Translucent colours.



REF. 211

- Lever mechanism with compressor bar for Archirrado Ref. 210 TL

COLOURS:

210 TL ORANGE	210 TL KIWI GREEN	210 TL RED	210 TL MAUVE
210 TL FUCHSIA	210 TL SEA BLUE	210 TL BLUE	210 TL GREEN

COLOURS:

211 NI NICKEL

ARCHIVOTEC SERIES 4000

Stackable Modular System Files

- Perfect Stackable Modular Filing System simply by placing one module over another.
- 5 drawers with security stop and with smooth sliding.
- Interior drawer measurements: 323 x 234 x 38 mm (depth x width x height).



REF. 4005

- 5-drawer module.
- Grey protective case. Opaque drawers.



COLOURS:

4005 BLACK	4005 GREY	4005 BLUE
4005 RED	4005 FUCHSIA	4005 SEA BLUE
4005 MAUVE	4005 KIWI GREEN	4005 WHITE

REF. 4005 TL

- 5-drawer module.
- Crystal clear translucent case.
- Translucent drawers.



COLOURS:

4005 TL KIWI GREEN	4005 TL FUCHSIA	4005 TL CRYSTAL
4005 TL ORANGE	4005 TL SEA BLUE	

Announcing display boards in PVC with 400 microns of thickness

- We manufacture any type of sign or display board, both in PVC or in aluminum, and with the text or colours you need (minimum order required).



✂ 50 🖨 SG ⌚ 50 🖋 50

We manufacture any type of made-to-measure sign or announcing board, both in PVC or Aluminum, and in any language.



➤ Serigraph printing using orange and black phosphorescent colours.

➤ Safety and evacuation signs, or exit and fire signage are photo-luminescent class B.



Special Sign manufacturing

 We are manufacturers

 Any type of Design

 Any color you want

 The exact size you need

Contact us!



PERSONALISED Products



 **Ultrasonic Welding**

 **Thermo Bonding**

 **Tampon Printing**

 **Serigraphy**

 **Thermal Printing**

 **IML**

More than 40 years in the business...

Archivo 2000 counts with a totally automated manufacturing process, which combined with its 5.000 square meters logistics warehouse and by means of an integral computer system management for storage and product dispatch, permits the company to render high quality services required by our clients.



www.archivo2000.com

Modular Organisers injected in high-quality transparent and bright polystyrene.

- Ideal for organising and classifying all types of small-sized office material in the interior of office filing cabinets, shelves or drawers.
- Its innovative clip system permits joining them together vertically as well as horizontally.
- There exist 9 different possibilities of classification: hollow spaces, with vertical or horizontal dividers or with different combinations of drawer arrangements.
- Each model includes 2 fastening plastic clips.
- Transparent colours.

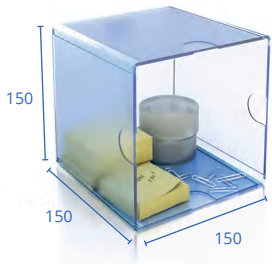

REF. 6701 TP

- Hollow space.

COLOURS:

6701 TP BLUE
6701 TP CRYSTAL

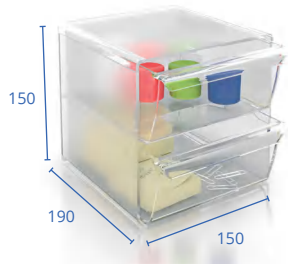

REF. 6702 TP

- 2 removable large-sized drawers.
- Interior drawers: 145 x 135 x 65 mm

COLOURS:

6702 TP BLUE
6702 TP CRYSTAL

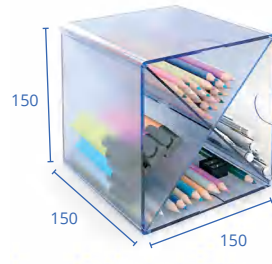

REF. 6703 TP

- Criss-cross divider.
- 4 compartments.

COLOURS:

6703 TP BLUE
6703 TP CRYSTAL

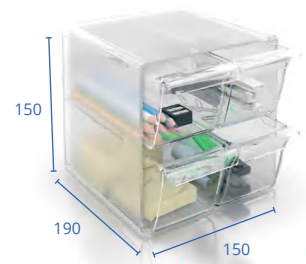

REF. 6704 TP

- 4 removable small-sized drawers.
- Interior drawers: 145 x 65 x 65 mm

COLOURS:

6704 TP BLUE
6704 TP CRYSTAL

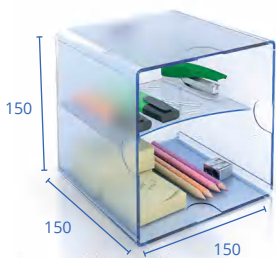
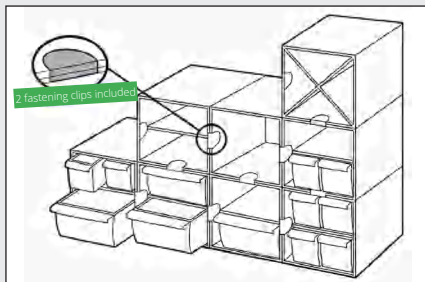

REF. 6705 TP

- With divider.
- Can be divided both horizontally and vertically.

COLOURS:

6705 TP BLUE
6705 TP CRYSTAL

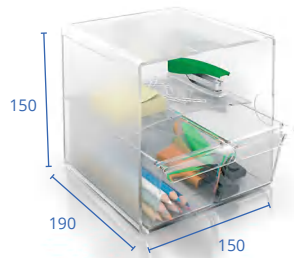

REF. 6706 TP

- 2 removable small-sized drawers.
- Interior drawers: 145 x 65 x 65 mm

COLOURS:

6706 TP BLUE
6706 TP CRYSTAL

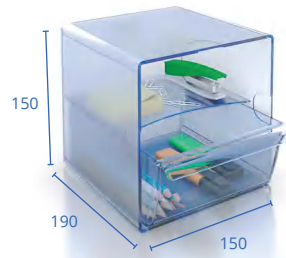

REF. 6707 TP

- 1 removable large-sized drawer.
- Interior drawers: 145 x 135 x 65 mm

COLOURS:

6707 TP BLUE
6707 TP CRYSTAL

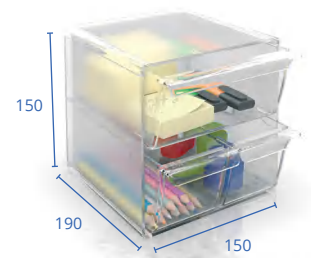

REF. 6708 TP

- 2 removable small-sized drawers and 1 large-sized drawer.

COLOURS:

6708 TP BLUE
6708 TP CRYSTAL

Display Brochure Holders with one or several pockets.

- Manufactured in high-gloss and premium quality polystyrene. We offer various types of brochure holders, with one or several stepped compartments, perfect for countertops and some models can be wall-mounted.



REF. 6141 TP

- 1/3 DIN A4 Portrait.
- Thickness 3 mm Ultrathick.
- Depth of box: 40 mm



REF. 6142 TP

- DIN A5 Portrait.
- Thickness 3 mm Ultrathick.
- Depth of box: 40 mm



REF. 6143 TP

- DIN A4 Portrait.
- Thickness 3 mm Ultrathick.
- Depth of box: 40 mm

PREMIUM



REF. DE77501 TP

- 1/3 DIN A4 Portrait High Back Single Compartment.



REF. DE74901 TP

- DIN A5 Portrait High Back Single Compartment.



REF. DE77001 TP

- DIN A4 Portrait High Back Single Compartment.



REF. DE77401 TP

- 3 Tier 6 Pocket 1/3 DIN A4 Portrait Multi Tiered.

Wall-mounting option



REF. DE77441 TP

- 4 Tier 4 Pocket DIN A4 Portrait Multi Tiered.



REF. DE77701 TP

- 4 Tier 4 Pocket 1/3 DIN A4 Portrait Multi Tiered.



REF. DE77901 TP

- 4 Tier DIN A5 Portrait Multi Tiered.



REF. DE693645

- 3 Tier for 1/3 DIN A4
- Steel-coloured



REF. DE693745

- 3 Tier DIN A4.
- Steel-coloured



✂ ✂ Name Holders.



- Perfect presentation with our name holders.
- Name holders of different sizes to adapt to the format of the document to be exhibited.
- Made of transparent crystal-coloured polystyrene.
- Possibility of making, on order, special-sized desktop or name holders.
- Consult minimum order required.



PREMIUM



REF. 6144P TP

- Small-sized Name Holder.

✂ 250 ○ 20
 🖨 SG 🖨 TG

REF. 6144G TP

- Large-sized Name Holder.

✂ 250 ○ 20
 🖨 SG 🖨 TG



REF. DE778901 TP

- Double-sided landscape.
- Width: DIN A6.

✂ 250 🖨 SG 🖨 TG



REF. DE48701 TP

- Double-sided landscape.
- Width: DIN A5.

✂ 250 🖨 SG 🖨 TG



REF. DE48601 TP

- Double-sided landscape.
- Width: DIN A4.

✂ 250 🖨 SG 🖨 TG



Slanted Sign Holders.

- L-shaped sign holders in multiple sizes, with one side visibility.
- Document can be side-loaded and their wide-base gives them high stability.
- Display cases manufactured in transparent crystal-coloured polystyrene.

PREMIUM



REF. 6145 TP

- DIN A5 Portrait.



REF. 6145A TP

- DIN A5 Landscape.

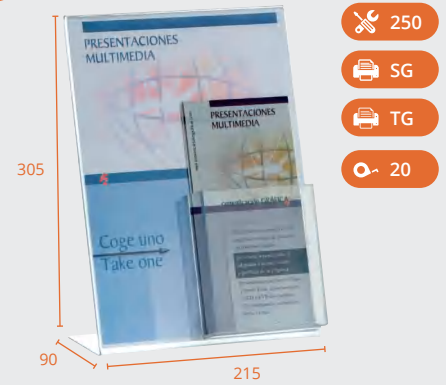

REF. 6146C TP

- Brochure holder display case in the front part for 1/3 DIN A4 Portrait.
- Depth of box: 30 mm



REF. 6146 TP

- DIN A4 Portrait.



REF. 6146A TP

- DIN A4 Landscape.



REF. 6150 TP

- Ideal size for numbering tables, prices...
- Landscape.



REF. 6150V TP

- Ideal size for numbering tables, prices...
- Portrait.



REF. DE480601 TP

- DIN A9 Portrait.
- Measurements: 25x37x52 mm



REF. DE480101 TP

- DIN A9 Landscape.
- Measurements: 22x54x40 mm



REF. DE480701 TP

- DIN A8 Portrait.
- Measurements: 37x54x77 mm



REF. DE480201 TP

- DIN A8 Landscape.
- Measurements: 35x78x55 mm



REF. DE480901 TP

- DIN A7 Portrait.
- Measurements: 41x75x110 mm



REF. DE480401 TP

- DIN A7 Landscape.
- Measurements: 38x105x77 mm



REF. DE480301 TP

- 60x90 mm Landscape.
- Measurements: 30x92x62 mm



REF. DE480801 TP

- 90x60 mm Portrait.
- Measurements: 30x62x92 mm



REF. DE45201 TP

- 1/3 DIN A4 Portrait.
- Measurements: 64x101x213 mm



REF. DE47501 TP

- DIN A5 Portrait.
- Measurements: 40x150x215 mm



REF. DE47505 TP

- DIN A5 Landscape.
- Measurements: 55x210x155 mm



REF. DE47401 TP

- DIN A4 Portrait.
- Measurements: 65x210x300 mm



REF. DE47301 TP

- DIN A4 Landscape.
- Measurements: 70x300x215 mm



REF. DE47601 TP

- DIN A3 Portrait.
- Measurements: 115x297x423 mm



REF. DE47611 TP

- DIN A3 Landscape.
- Measurements: 107x421x302 mm



Stand - up Sign Holders.

- Stand - up Sign Holders in multiple sizes, with double-sided visibility.
- The document is loaded from the bottom and their wide base make them very stable.
- Display cases manufactured in transparent crystal-coloured polystyrene.
- Possibility of making, on order, special sized Stand - up Sign Holders.
- Consult minimum order required.

- 250
- SG
- TG
- 20



REF. 6147 TP

- DIN A5 Portrait.

PREMIUM

- 250
- SG
- TG
- 20



REF. 6147A TP

- DIN A5 Landscape.

- 250
- SG
- TG
- 20



REF. 6148 TP

- 1/3 DIN A4 Portrait.

- 250
- SG
- TG
- 20



REF. 6149 TP

- DIN A4 Portrait.

- 250
- SG
- TG
- 20

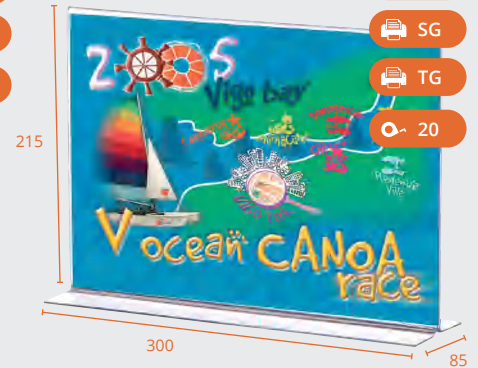

REF. 6149A TP

- DIN A4 Landscape.





REF. DE684301 TP

• DIN A6 Portrait.



REF. DE684401 TP

• DIN A6 Landscape.



REF. DE45101 TP

• 1/3 DIN A4 Portrait.



REF. DE47901 TP

• DIN A5 Portrait.



REF. DE47905 TP

• DIN A5 Landscape.



REF. DE47801 TP

• DIN A4 Portrait.



REF. DE47701 TP

• DIN A4 Landscape.



REF. DE48001 TP

• DIN A3 Portrait.



REF. DE48011 TP

• DIN A3 Landscape.



Swivel Sign Holders.



- Smooth turning which permits viewing of documents on both sides or from an angle.
- Manufactured in methacrylate (PMMA).
- Document is easily top-loaded or side-loaded into the display case.
- Elegant silver-coloured base.



REF. DE691001 TP

- 1/3 DIN A4 Portrait.
- Measurements: 50 x 102 x 236 mm (depth x width x height).

REF. DE691201 TP

- DIN A5 Portrait.
- Measurements: 50 x 151 x 236 mm (depth x width x height).

REF. DE691101 TP

- DIN A4 Portrait.
- Measurements: 65 x 214 x 327 mm (depth x width x height).

Curved Magnetic Sign Holders.



- Transparent display cases with bevelled edges that make them have a glass appearance.
- Magnetic front panel that clips perfectly into back panel by means of small embedded magnets in each corner, allowing to easily change documents.
- Curved surface with black frame.



REF. DE680575 TP

- DIN A5 Landscape.
- Measurements: 50 x 230 x 175 mm (depth x width x height).

REF. DE680475 TP

- DIN A4 Landscape.
- Measurements: 80 x 295 x 237 mm (depth x width x height).

Bevelled Edge Slanted Sign Holders.



- High quality display cases with green tinted edge that gives them a glass appearance.
- Can be positioned either vertically or horizontally.
- The metal pegs can be easily unscrewed in order to change the document and its orientation.



REF. DE799693 TP

- DIN A4 Portrait.
- Measurements: 85 x 256 x 320 mm (depth x width x height).

REF. DE799783 TP

- DIN A4 Portrait.
- Measurements: 85 x 272 x 324 mm (depth x width x height).

Multi-sided Sign Holders.



- Countertop sign holders with 2 and 3 sides.
- Graphics can be easily replaced.
- Perfect display cases for hotels and restaurants.
- Manufactured in transparent crystal-coloured polystyrene.



PREMIUM



REF. 6153 TP

- 3-sided sign holder.



REF. DE60101 TP

- 3-sided sign holder.



REF. DE61701 TP

- Double-sided sign holder for maximum impact.



Menu Holders.

- Display cases and clips in methacrylate (PMMA).
- Practical and simple to exhibit information, as for example, restaurant menus.
- Clips have a simple design to exhibit menus, information, business cards, etc.
- Double-sided menu holder also permits you to exhibit information in its interior.

REF. DEMC100YT TP

- Crystal Menu Clip Holder - 100 mm wide.

250
SG
TG

REF. DEM150YT TP

- Double-sided. Space to exhibit a document on each side and to hold the menu in the middle of both.

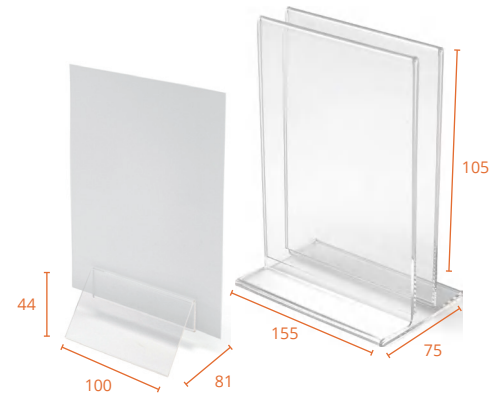

Book / Diary Stand.

- Both are very useful and make exhibition of documents easy.
- These slanted and stable supports made of methacrylate, are perfect for exhibiting books, newspapers, tablets and mobiles.

250
SG
TG



REF. DE771101 TP

- Small-sized slanted display support.
- Measurements: 99 x 50 x 109 mm

REF. DE771801 TP

- Large-sized slanted display support.
- Measurements: 130 x 50 x 180 mm

Card Holder Displays.

- Card Holder available with one or more pockets and a one-compartment wall-mounted business card dispenser.
- Manufactured in transparent crystal-coloured polystyrene.

250 SG TG



REF. DE70101 TP

- Card Holder display with 1 horizontal pocket.
- Capacity: 50 cards.



REF. DE70841 TP

- 4-Tier Card Holder display with 4 horizontal pockets.
- Capacity: 50 cards per pocket.



REF. DE70801 TP

- 4-Tier Card Holder display with 8 horizontal pockets.
- Capacity: 50 cards per pocket.



REF. DE70901 TP

- Wall-mounted display case for business cards.
- Maximum capacity: 50 cards
- Comes with drilled-holes on the back and optional adhesives.

PREMIUM



REF. 6151 TP

- Card Holder with 2 pockets: 1 in the rear part to exhibit a business card and another in the front to place a stack of cards.
- Landscape.



REF. 6151V TP

- Card Holder with 2 pockets: 1 in the rear part to exhibit a business card and another in the front to place a stack of cards.
- Portrait.

250 SG TG 20

250 SG TG 20

☒☒ Suggestion and Ballot Boxes.



- Perfect for business cards, coins, raffle tickets, forms, etc...
- These countertop multi-use boxes permit you to fix information sheets at the rear.
- Manufactured in transparent crystal-coloured polystyrene.

PREMIUM



✂ 100 🖨 SG 🖨 TG ⚙ 20

REF. 6152 TP

- Suggestion box without key.
- With space to be personalised.
- Slot measurements: 10 x 95 mm

REF. 6152LL TP

- Suggestion box with key.
- With space to be personalised.
- Slot measurements: 10 x 95 mm



✂ 100 🖨 SG 🖨 TG

REF. 6158 TP

- Ballot box. Standard model.
- Includes 2 security seals.
- Slot measurements: 180 x 8 mm
- Color base: White



REF. 6158P

- Pack of 10 security seals for ballot box Ref. 6158 TP.



REF. DE592901 TP

- Suggestion box with rear part for brochure with measurements; 152 x 102 mm
- Slot measurements: 89 x 6.4 mm

✂ 100 🖨 SG 🖨 TG



REF. DE596901 TP

- Suggestion box with key, and with rear part for brochure with measurements; 152 x 102 mm
- Slot measurements: 89 x 6.4 mm

✂ 100 🖨 SG 🖨 TG



REF. DE66001 TP

- Suggestion box with rear part for brochure with measurements; 201 x 375 mm
- Slot measurements: 102 x 6.4 mm

✂ 100 🖨 SG 🖨 TG

Wall-Mounted Display Cases (with adhesive).

- They can be mounted on any smooth surface using the adhesive on the back.
- The adhesive avoids having to perforate the surface.



PREMIUM

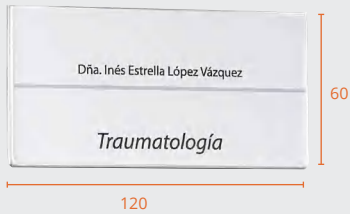

REF. 6154P TP

- Wall-mounted name holder.
- Small-sized.
- Measurements: 60 x 120 mm

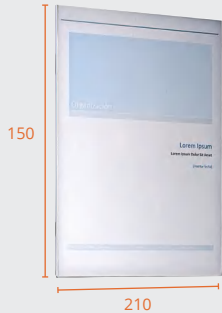

REF. 6155 TP

- DIN A5 Portrait.



REF. 6156 TP

- DIN A4 Portrait.



REF. 6157 TP

- DIN A3 Portrait.

REF. 6154G TP

- Wall-mounted name holder.
- Large-sized.
- Measurements: 60 x 210 mm

REF. 6155A TP

- DIN A5 Landscape.

REF. 6156A TP

- DIN A4 Landscape.

REF. 6157A TP

- DIN A3 Landscape.



Wall-mounted Display Cases (with drilled holes).

- Wall-mounted sign holders in different sizes with pre-drilled holes for easy wall fixing.
- Document can be changed easily without having to remove display case from wall.
- Manufactured in transparent crystal-coloured polystyrene.



REF. DE47101 TP

- DIN A5 Portrait.



REF. DE47001 TP

- DIN A4 Portrait.
- Measurements: 212 x 324 mm



REF. DE47201 TP

- DIN A3 Portrait.
- Measurements: 300 x 445 mm

REF. DE46901 TP

- DIN A4 Landscape.

REF. DE48000 TP

- DIN A3 Landscape.

Wall-mounted Brochure Holder (1 pocket).

- One-pocket brochure holder with drilled holes in rear part for easy wall fixing.
- Front slit to have easy access to brochures and documents.
- Manufactured in transparent crystal-coloured polystyrene.

PREMIUM

250

SG

TG

1000



REF. 9005 TP

- DIN A4 Portrait.
- Pocket depth: 45 mm

250

SG

TG

1000



REF. 9006 TP

- 1/3 DIN A4 Portrait.
- Pocket depth: 40 mm

250

SG

TG

1000



REF. 9007 TP

- DIN A5 Portrait.
- Pocket depth: 40 mm

Retail Store Displays (Magnetic Acrylic Blocks).

- The acrylic panels are perfectly held together by means of small magnets in each corner, allowing to easily change documents.
- Can be displayed vertically or horizontally.
- The 15 mm frames consist of two 8 mm thick acrylic panels.
- The 30 mm frames consist of two 15 mm thick acrylic panels.
- Transparent crystal-coloured.

250

SG

TG



REF. DEMCHBC11 TP

- 15 mm Magnetic Acrylic Block. Business card size.
- Measurements: 15 x 95 x 65 mm

REF. DEMCHA511 TP

- 15 mm Magnetic Acrylic Block. DIN A5.
- Measurements: 15 x 210 x 150 mm

250

SG

TG



REF. DEMHBC11-30 TP

- 30 mm Magnetic Acrylic Block. Business card size.
- Measurements: 30 x 95 x 65 mm

REF. DEMCHA511-30 TP

- 30 mm Magnetic Acrylic Block. DIN A5.
- Measurements: 30 x 210 x 150 mm

REF. DEMCHA611-30 TP

- 30 mm Magnetic Acrylic Block. DIN A6.
- Measurements: 30 x 150 x 105 mm

REF. DEMCHA411-30 TP

- 30 mm Magnetic Acrylic Block. DIN A4.
- Measurements: 30 x 210 x 300 mm

Stackable Trays.

- Stackable organising trays.
- For documents DIN A4 and Folio formats.
- Allows you to organize your documents with colour and style.
- Slot on the front for easy access.

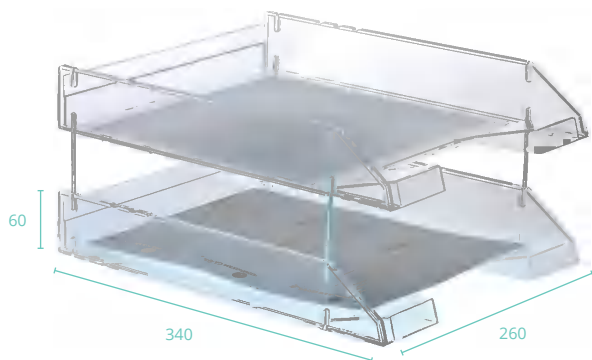

REF. 715 TP

- Smooth surface. Possibility of using riser rods to increase capacity, making access to documents easy.
- Transparent colours.



COLOURS:

715 TP CRYSTAL
715 TP SMOKED

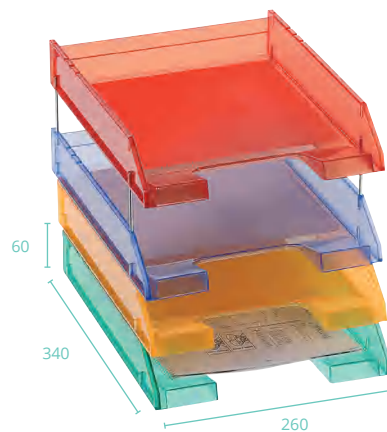

REF. 715 TL

- Smooth surface. Possibility of using riser rods to increase capacity, making access to documents easy.
- Translucent colours.



COLOURS:

715 TL BLUE	715 TL FUCHSIA	715 TL ORANGE
715 TL RED	715 TL GREEN	715 TL SEA BLUE
715 TL MAUVE	715 TL KIWI GREEN	



REF. 2610

- Set of 4 riser rods for a 50 mm separation between trays.
- Valid for Ref. 715 TP and 715 TL.
- Measurements: 3.6 x 80 mm

REF. 2611

- Set of 4 riser rods for a 100 mm separation between trays.
- Valid for Ref. 715 TP and 715 TL.
- Measurements: 3.6 x 130 mm

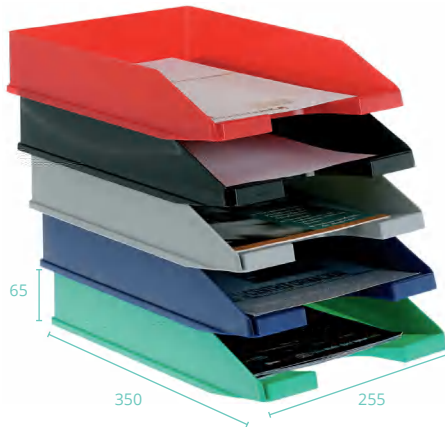

**REF. 740**

- Smooth surface.
- Stackable with 3 positions.
- Opaque colours.

**COLOURS:**

740 GREY 740 GREEN 740 BLUE
740 RED 740 BLACK

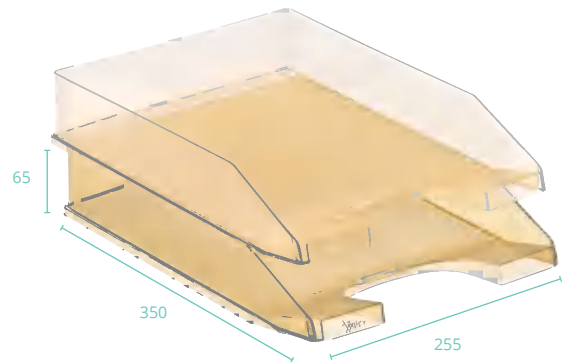
**REF. 741 TP**

- Smooth surface.
- Stackable with 3 positions.
- Transparent colours.

**COLOURS:**

741 TP CRYSTAL 741 TP SMOKED

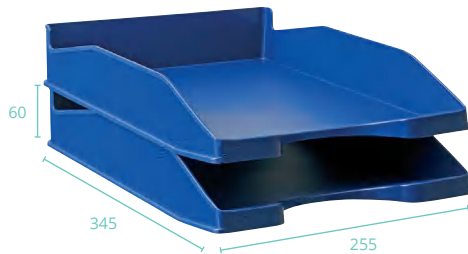
**REF. 742**

- Smooth surface.
- Stackable with 3 positions.
- Opaque colours.

**COLOURS:**

742 GREY
742 GREEN
742 BLUE
742 RED
742 BLACK

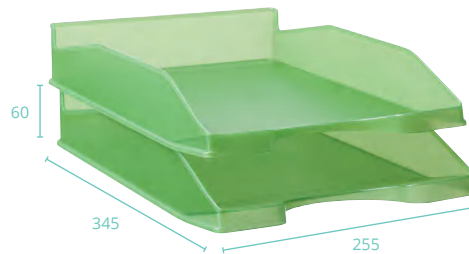
**REF. 742 TL**

- Smooth surface.
- Stackable with 3 positions.
- Translucent colours.

**COLOURS:**

742 TL BLUE
742 TL FUCHSIA
742 TL ORANGE
742 TL RED
742 TL GREEN
742 TL SEA BLUE
742 TL MAUVE
742 TL KIWI GREEN

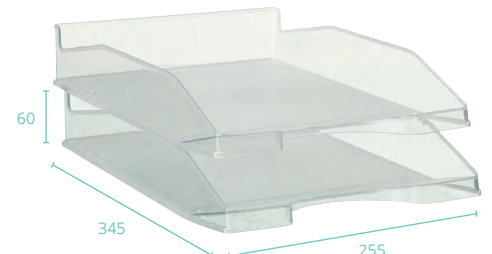
**REF. 742 TP**

- Smooth surface.
- Stackable with 3 positions.
- Transparent colours.

**COLOURS:**

742 TP CRYSTAL
742 TP SMOKED

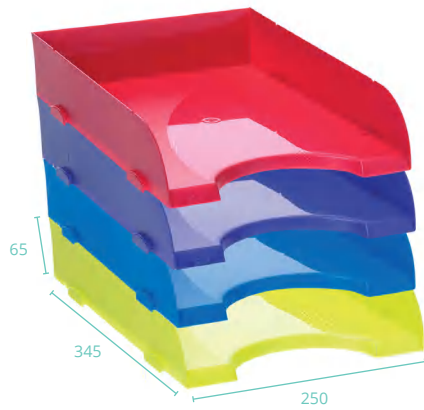
**REF. 745**

- Smooth surface. Stackable.
- Special surface finish combines high gloss and matt areas.
- Opaque colours.

**COLOURS:**

745 GREY	745 GREEN	745 BLUE
745 RED	745 BLACK	745 FUCHSIA
745 MAUVE	745 SEA BLUE	745 KIWI GREEN
745 WHITE		

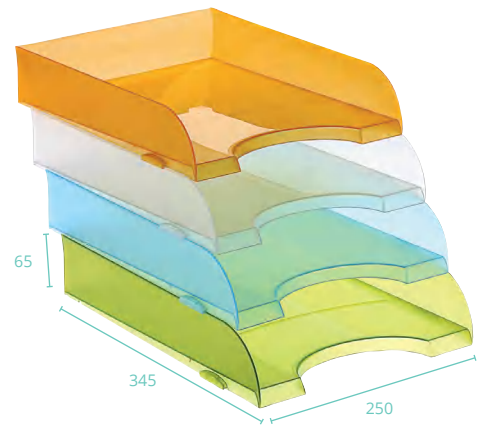
**REF. 745 TL**

- Smooth surface.
- Stackable with 3 positions.
- Translucent colours.

**COLOURS:**

745 TL BLUE	745 TL RED	745 TL ORANGE
745 TL CRYSTAL	745 TL GREEN	745 TL SEA BLUE
745 TL MAUVE	745 TL KIWI GREEN	

JumboRack.

- 3 trays with riser rods for DIN A4 and Folio formats.
- JumboRack consists of a set of 3 trays with riser rods.
- Individual tray dimensions: 350 x 255 x 65 mm (depth x width x height).

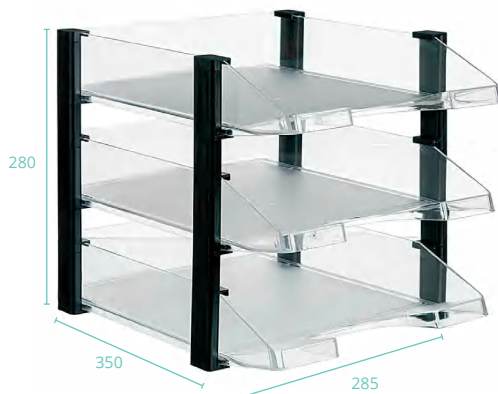
**REF. 704 TP**

- Set of 3 trays with riser rods.
- Tray colour: Transparent Crystal.
- Colour of rods: Black.



Filing Boxes.



- Filing boxes with an attractive design. Specially designed to file catalogues, magazines, brochures, etc...
- Permits you to locate and visualise the contents easily.
- Offers great capacity and stability and permits you to keep documents well organised, classified and always at hand.
- Thumb hole on spine makes handling easy.



REF. 2003

- Great capacity.
- 80 mm spine.
- Opaque colours.

COLOURS:

2003 GREY	2003 GREEN
2003 BLUE	2003 RED
2003 BLACK	2003 FUCHSIA
2003 MAUVE	2003 SEA BLUE
2003 KIWI GREEN	2003 WHITE

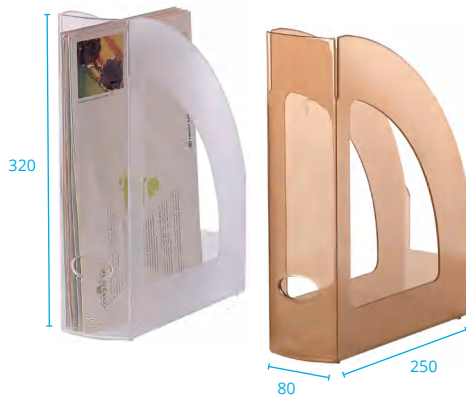

REF. 2004 TP

- Great capacity.
- 80 mm spine.
- Transparent colours.

COLOURS:

2004 TP CRYSTAL	2004 TP SMOKED
-----------------	----------------

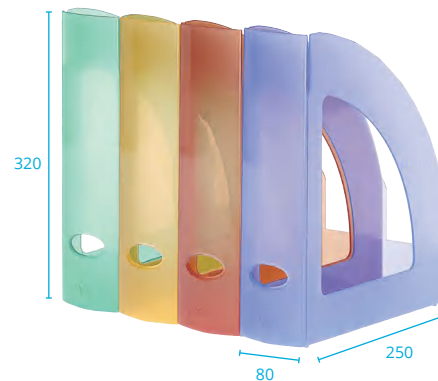

REF. 2004 TL

- Great capacity.
- 80 mm spine.
- Translucent colours.

COLOURS:

2004 TL BLUE	2004 TL FUCHSIA
2004 TL ORANGE	2004 TL RED
2004 TL GREEN	2004 TL SEA BLUE
2004 TL MAUVE	2004 TL KIWI GREEN



REF. 2005

- 75 mm spine. Comes with identification tab holder (48 x 87 mm) on spine and anchor points in order to form sets.
- Opaque colours.

COLOURS:

2005 GREY	2005 GREEN	2005 BLUE
2005 RED	2005 BLACK	

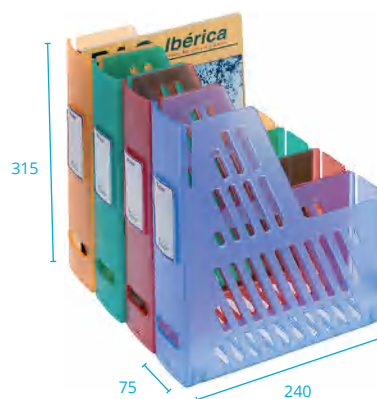

REF. 2005 TL

- 75 mm spine. Comes with identification tab holder (48 x 87 mm) on spine and anchor points in order to form sets.
- Translucent colours.

COLOURS:

2005 TL BLUE	2005 TL RED	2005 TL ORANGE
2005 TL CRYSTAL	2005 TL GREEN	2005 TL SEA BLUE
2005 TL MAUVE	2005 TL KIWI GREEN	2005 TL FUCHSIA

Plastic Waste Paper Bins.

- Wide range of waste paper bins highly resistant to bumps and scratches.
- Easy to transport and clean they are ideal for any type of office or workplace.

SG TG IML 500



REF. 2001

250

- 16 litres capacity. Stackable.
- Comes with ring to hold in place the bag inside the bin (optional).
- Opaque colours.
- Made of polypropylene copolymer.

COLOURS:

2001 GREY	2001 GREEN
2001 BLUE	2001 RED
2001 BLACK	



REF. 2001 TL

250

- 16 litres capacity. Stackable.
- Comes with ring to hold in place the bag inside the bin (optional).
- Translucent colours.
- Made of polypropylene copolymer.

COLOURS:

2001 TL BLUE	2001 TL RED
2001 TL ORANGE	2001 TL CRYSTAL
2001 TL GREEN	2001 TL SEA BLUE
2001 TL MAUVE	2001 TL KIWI GREEN
2001 TL FUCHSIA	



REF. 2002

250

- 14 litres capacity. Stackable.
- Opaque colours.
- Made of high gloss polypropylene copolymer.

COLOURS:

2002 GREY	2002 GREEN
2002 BLUE	2002 RED
2002 BLACK	



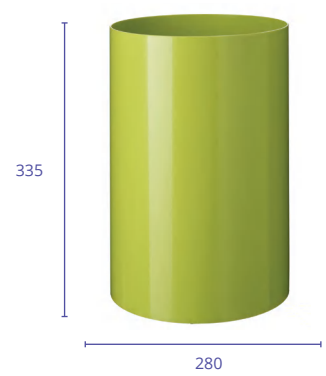
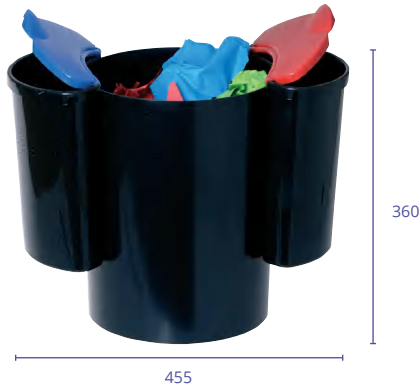

REF. 2000 E2



- Recycling bins with 2 selective containers.
- Lid colour of containers: red, blue, yellow and green. Colour of bin and selective containers: black.
- Made of polystyrene and polypropylene.

COLOURS:

- 2000E2 BLUE-RED
- 2000E2 YELLOW-RED
- 2000E2 BLUE-YELLOW
- 2000E2 YELLOW-GREEN
- 2000E2 BLUE-GREEN
- 2000E2 GREEN-RED

REF. 2000 TL



- 17 litres capacity.
- Translucent colours.
- Made of polystyrene.

COLOURS:

- | | |
|-----------------|--------------------|
| 2000 TL BLUE | 2000 TL RED |
| 2000 TL ORANGE | 2000 TL CRYSTAL |
| 2000 TL GREEN | 2000 TL SEA BLUE |
| 2000 TL MAUVE | 2000 TL KIWI GREEN |
| 2000 TL FUCHSIA | |

REF. 2000



- 17 litres capacity.
- Opaque colours.
- Made of polystyrene.

COLOURS:

- | | |
|--------------|-----------------|
| 2000 GREY | 2000 GREEN |
| 2000 BLUE | 2000 RED |
| 2000 BLACK | 2000 SEA BLUE |
| 2000 MAUVE | 2000 KIWI GREEN |
| 2000 FUCHSIA | |
| 2000 WHITE | |

Umbrella Stands and Floor Ashtrays.



- Umbrella stands and floor ashtrays.
- Highly resistant to bumps, scratches and cleaning products.
- Easy to clean. Ideal for all types of offices, commercial premises and department stores.



REF. 2100

- Umbrella holder injected in polystyrene, highly resistant to bumps, scratches and cleaning products.
- They don't rust because they are plastic.
- Opaque colours.

COLOURS:

- | | | |
|------------|------------|-----------|
| 2100 GREY | 2100 RED | 2100 BLUE |
| 2100 BEIGE | 2100 BLACK | |

REF. 2200

- Floor standing ashtray injected in polystyrene highly resistant to bumps, scratches and cleaning products.
- They don't rust because they are plastic.
- Metal-chromated cover on upper part. Opaque colours.

COLOURS:

- | | | |
|------------|------------|-----------|
| 2200 GREY | 2200 RED | 2200 BLUE |
| 2200 BEIGE | 2200 BLACK | |

Archibox.

- Highly resistant plastic suspension file box for hanging folders DIN A4 with top vision.
- Injected in high impact polystyrene of great resistance.
- Designed with lateral handles which permits the filing and transport of approximately 20 folders.
- Opaque colours.



REF. 2006

- Includes 5 hanging coloured folders with tabs and inserts.

COLOURS:

2006 GREY	2006 BLACK
2006 BLUE	2006 RED

REF. 2007

- Folders not included.

COLOURS:

2006 GREY	2006 BLACK
2006 BLUE	2006 RED

Storage.

- Order and versatility all in one!
- Boxes that cover all your storage needs, starting from 0.07 litres to 84 litres of capacity.
- Made of polypropylene. They stand out for their optimum resistance to temperatures between -15°C and +80°C. Stackable with or without lids.
- Minimum wall thickness to guarantee its storing capacity and ergonomic design.
- Rear part totally leveled and reinforced. With locking system to avoid lid from separating from base.

**MORE THAN
30 COLOURS
AVAILABLE!
PLEASE
CONTACT US**

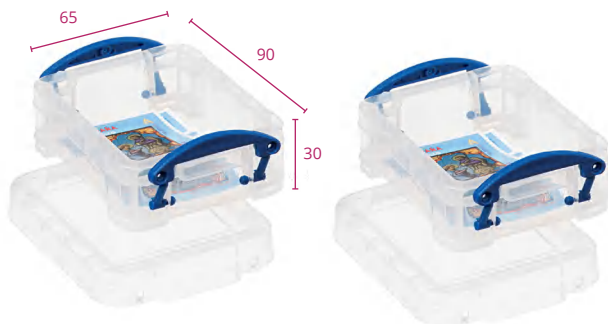

REF. RU0.07 (PACK OF 5)

- Pack of 5 boxes with 0.07 litres of capacity.
- With lid. Interior measurements: 61 x 48 x 24 mm



COLOURS:

RU0.07 5X ASSORTED	RU0.07 5X CRYSTAL
--------------------	-------------------

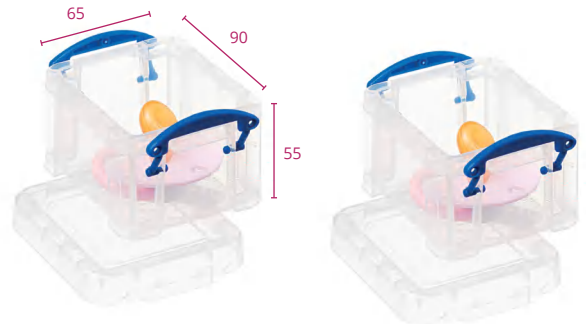

REF. RU0.014 (PACK OF 5)

- Pack of 5 boxes with 0.14 litres of capacity.
- With lid. Interior measurements: 64 x 48 x 42 mm



COLOURS:

RU0.14 5X ASSORTED	RU0.14 5X CRYSTAL
--------------------	-------------------



REF. RU0.3

- Box with 0.30 litres of capacity.
- With lid.
- Ideal for business cards.
- Interior measurements: 90x65x55 mm



REF. RU0.55

- Box with 0.55 litres of capacity.
- With lid.
- Interior measurements: 185x80x30 mm



REF. RU0.7

- Box with 0.70 litres of capacity.
- With lid.
- Interior measurements: 120x80x70 mm



**MORE THAN
30 COLOURS
AVAILABLE!
PLEASE
CONTACT US**

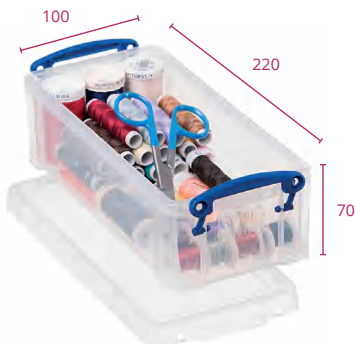

REF. RU0.9

- Box with 0.90 litres of capacity.
- With lid.
- Interior measurements: 185x80x60 mm



REF. RU1.6

- Box with 1.60 litres of capacity.
- With lid.
- Interior measurements: 150x110x95 mm

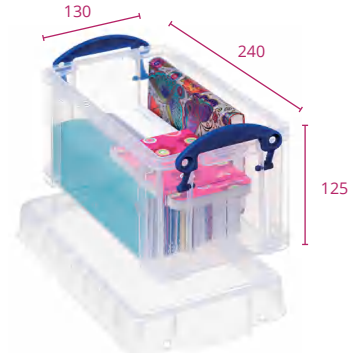

REF. RU2.1

- Box with 2.10 litres of capacity.
- With lid.
- Interior measurements: 190x100x104 mm





MORE THAN
30 COLOURS
AVAILABLE!
PLEASE
CONTACT US

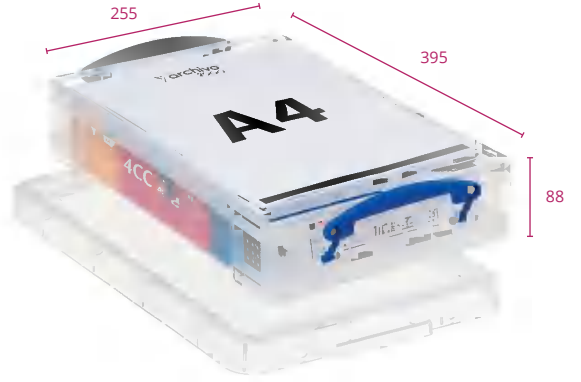

REF. RU3

- Box with 3 litres of capacity. With lid.
- Perfect for storing CDs and DVDs.
- Interior measurements: 190x143x120 mm



REF. RU4

- Box with 4 litres of capacity. With lid.
- Perfect for storing paper format DIN A4 and folio.
- Interior measurements: 348x220x68 mm

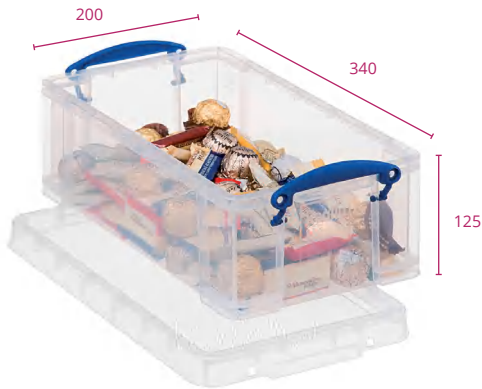

MORE THAN
30 COLOURS
AVAILABLE!
PLEASE
CONTACT US



REF. RU5

- Box with 5 litres of capacity.
- With lid.
- Interior measurements: 285x160x105 mm



REF. RU8

- Box with 8 litres of capacity. With lid.
- Front and top opening.
- Interior measurements: 290x165x153 mm



MORE THAN
30 COLOURS
AVAILABLE!
PLEASE
CONTACT US

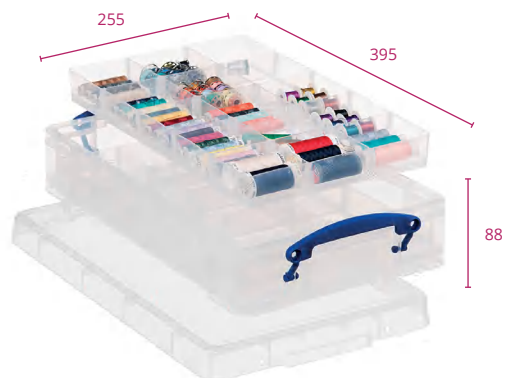

REF. RU9

- Box with 9 litres of capacity. With lid.
- Perfect for storing paper format DIN A4 and folio.
- Interior measurements: 348x220x140 mm



REF. RU4-2X15

- Box with 4 litres of capacity, with 2 removable interior trays with 15 compartments each.
- With lid.
- Interior measurements: 348x220x68 mm





REF. RU14

- Box with 14 litres of capacity. With lid.
- Front and top opening.
- Interior measurements: 336x214x190 mm

COLOURS:

RU14 CRYSTAL

RU14 SEA BLUE

RU14 FUCHSIA

RU14 KIWI GREEN

RU14 MAUVE

RU14 ORANGE

**MORE THAN
30 COLOURS
AVAILABLE!
PLEASE
CONTACT US**

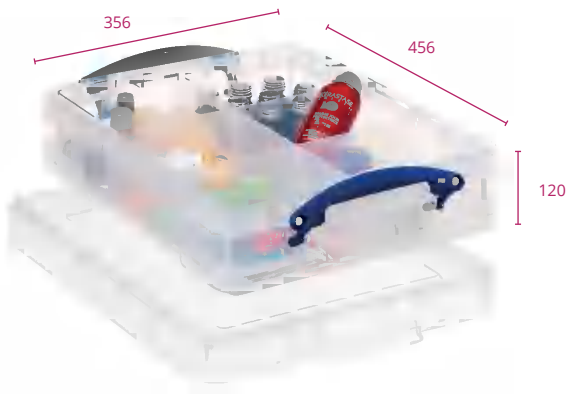

REF. RU11-6

- Box with 11 litres of capacity.
- With 1 removable interior tray with 6 compartments.
- With lid. Interior measurements: 375x310x91 mm



**MORE THAN
30 COLOURS
AVAILABLE!
PLEASE
CONTACT US**

REF. RU19

- Box with 19 litres of capacity.
- Valid for hanging folders with format DIN A4.
- Interior measurements: 315X205X270 mm



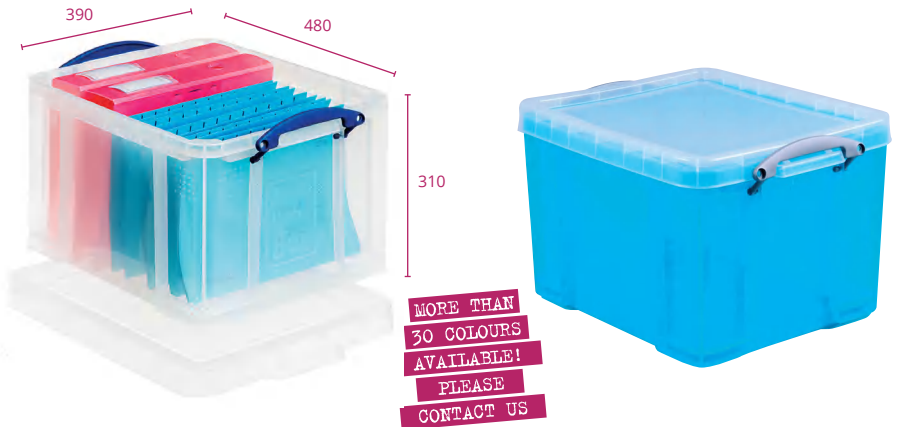
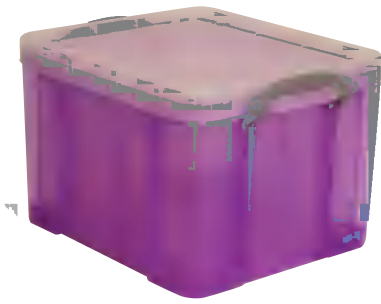

MORE THAN
30 COLOURS
AVAILABLE!
PLEASE
CONTACT US

REF. RU35

- Box with 35 litres of capacity. With lid.
- Valid for hanging folders format DIN A4.
- Interior measurements: 370x310x280 mm



COLOURS:

RU35 CRYSTAL	RU35 MAUVE	RU35 KIWI GREEN
RU35 ORANGE	RU35 FUCHSIA	RU35 SEA BLUE



MORE THAN
30 COLOURS
AVAILABLE!
PLEASE
CONTACT US



REF. RU35XL

- Box with 35 litres of capacity.
- With XL lid that increases its capacity.
- Valid for hanging folders format DIN A4 and vinyl LPs
- Interior measurements: 370x310x345 mm



REF. RU48

- Box with 48 litres of capacity. With lid.
- Valid for hanging folders format DIN A4.
- Interior measurements: 530x325x289 mm

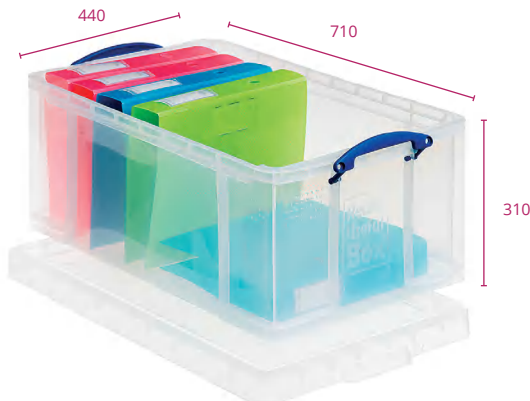

MORE THAN
30 COLOURS
AVAILABLE!
PLEASE
CONTACT US

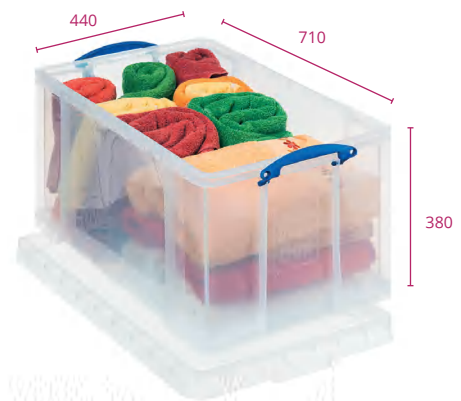

REF. RU64

- Box with 64 litres of capacity. With lid.
- Valid for hanging folders format large folio.
- Interior measurements: 605x370x280 mm



REF. RU84 CS TP

- Box with 84 litres of capacity.
- With lid.
- Interior measurements: 605x370x355 mm



Box Organisers.



- A fun way to store small objects.
- These box organisers can be placed either on desktops or on walls, thanks to the drilled holes in the carcasses' rear panel.
- Transparent crystal-coloured carcasses, of different shapes.
- All boxes included inside the carcasses are stackable and come with lid.
- The exterior measurements include the boxes with handles.
- Made of polypropylene.

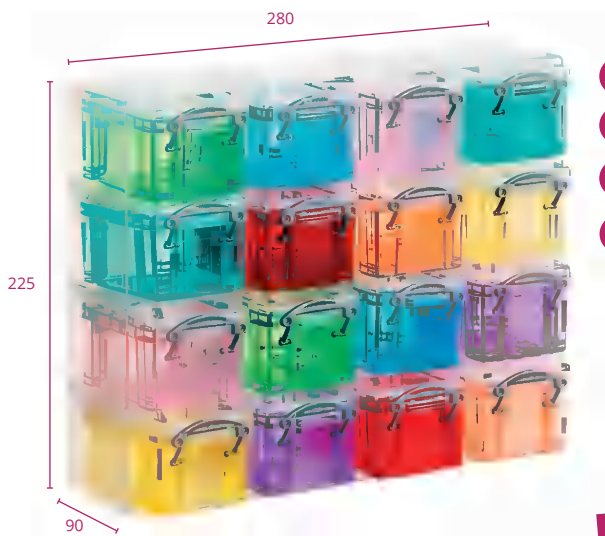

- ✂ 150
- 🖨 SG
- 🖨 TG
- 🔪 1000

REF. RUOS16

- Square-shaped box organiser with 16 stackable boxes of 0.14 litres each and with lid.

COLOURS:

- RUOS16 TRANSPARENT CRYSTAL
- RUOS16 ASSORTED

**MORE THAN
30 COLOURS
AVAILABLE!
PLEASE
CONTACT US**



REF. RUOSH6-1

- Small heart-shaped box organiser.
- Includes 6 boxes of 0.14 litres and 1 box of 0.07 litres.

- ✂ 150
- 🖨 SG
- 🖨 TG
- 🔪 1000

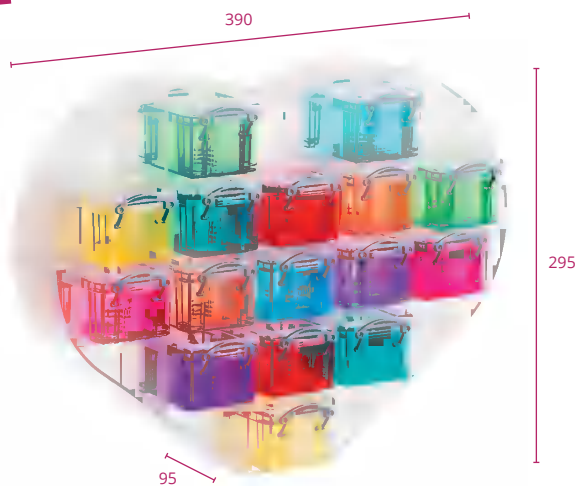

REF. RUOBH16

- Large heart-shaped box organiser.
- Includes 16 boxes of 0.14 litres.

- ✂ 150
- 🖨 SG
- 🖨 TG
- 🔪 1000



MORE THAN
30 COLOURS
AVAILABLE!
PLEASE
CONTACT US

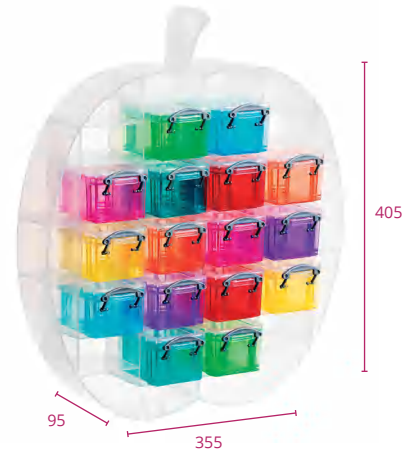

REF. RUOSA7

- Small apple-shaped box organiser.
- Includes 7 boxes of 0.14 litres.



REF. RUOBA16

- Large apple-shaped box organiser.
- Includes 16 boxes of 0.14 litres.



Tube-shaped containers.

- Tube-shaped containers with lid.
- Perfect for storing any type of object: from nails, pens and pencils, to paint brushes, rulers and even knitting needles.
- Made of polypropylene.

MORE THAN
30 COLOURS
AVAILABLE!
PLEASE
CONTACT US



REF. RUC0.15

- Capacity: 0.15 litres.
- Top opening.
- Interior measurements: 88 x 49 mm

REF. RUC0.29

- Capacity: 0.29 litres.
- Top opening.
- Interior measurements: 175 x 49 mm

REF. RUC0.32

- Capacity: 0.32 litres.
- Half-open position.
- Interior measurements: 175 x 49 mm

REF. RUC0.50

- Capacity: 0.50 litres.
- Half-open position..
- Interior measurements: 263 x 49 mm

REF. RUC0.60

- Capacity: 0.60 litres.
- Half-open position.
- Interior measurements: 337 x 49 mm



Desk Calendar Holder.

- Desk calendar holders to have your daily planning always at sight and be able to organize your day-to-day itinerary.

250 SG TG 1000

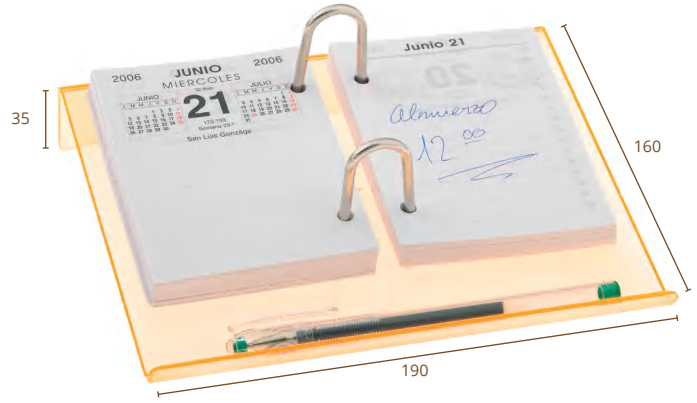
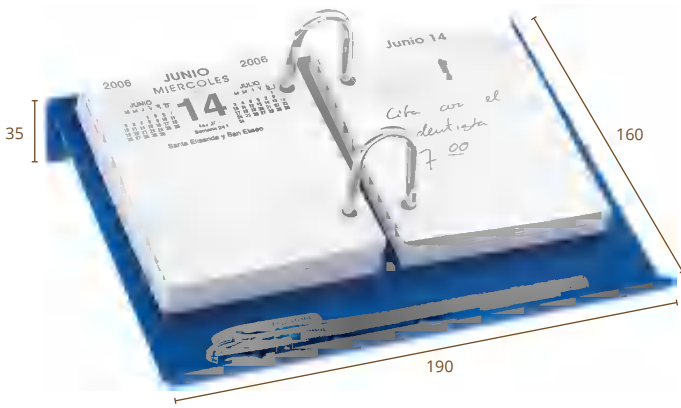

REF. 784

- With metallic rings.
- Does not include calendar refill.
- Opaque colours.

COLOURS:

784 GREY 784 GREEN
784 BLUE 784 RED
784 BLACK

REF. 784 TP

- With metallic rings.
- Does not include calendar refill.
- Transparent colours.

COLOURS:

784 TP CRYSTAL 784 TP SMOKED

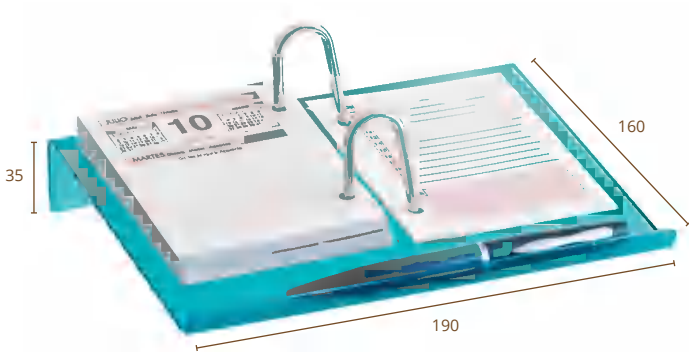

REF. 784 TL

- With metallic rings.
- Does not include calendar refill.
- Translucent colours.

COLOURS:

784 TL BLUE 784 TL FUCHSIA
784 TL ORANGE 784 TL RED
784 TL GREEN 784 TL SEA BLUE
784 TL MAUVE 784 TL KIWI GREEN

✦✦ Pencil Cups.

- ✦✦ • Desktop pencil cups to always have easy access to you pens and pencils.



REF. 770

- Round-shaped pencil cup.
- Great capacity and stability.
- Opaque colours.

COLOURS:

770 GREY	770 GREEN	770 BLUE
770 RED	770 BLACK	



REF. 770 TL

- Round-shaped pencil cup.
- Great capacity and stability.
- Translucent colours.

COLOURS:

770 TL BLUE	770 TL RED	770 TL ORANGE
770 TL CRYSTAL	770 TL GREEN	770 TL SEA BLUE
770 TL MAUVE	770 TL KIWI GREEN	770 TL FUCHSIA



REF. 771

- Round-shaped pencil cup.
- Great capacity.
- Opaque colours.

COLOURS:

771 GREY	771 GREEN
771 BLUE	771 RED
771 BLACK	771 FUCHSIA
771 SEA BLUE	771 MAUVE
771 KIWI GREEN	771 WHITE

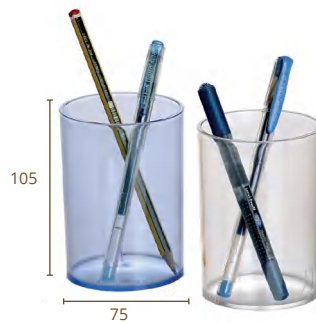

REF. 771 TP

- Round-shaped pencil cup.
- Great capacity.
- Transparent colours.

COLOURS:

771 TP CRYSTAL	771 TP SMOKED
----------------	---------------



REF. 771 TL

- Round-shaped pencil cup.
- Great capacity.
- Translucent colours.

COLOURS:

771 TL BLUE	771 TL FUCHSIA
771 TL ORANGE	771 TL RED
771 TL GREEN	771 TL SEA BLUE
771 TL MAUVE	771 TL KIWI GREEN

250

SG

TG



REF. 786 TP

- Square-shaped pencil cup.
- Transparent colour.

250

SG

TG

IML

1000



REF. 790 TL

- Round-shaped pencil cup. Translucent colours.

COLOURS:

790 TL BLUE	790 TL FUCHSIA	790 TL ORANGE
790 TL RED	790 TL GREEN	790 TL SEA BLUE
790 TL MAUVE	790 TL KIWI GREEN	

250

SG

TG

IML

1000



REF. 790 TP

- Round-shaped pencil cup. Transparent colours.

COLOURS:

790 TP CRYSTAL	790 TP SMOKED
----------------	---------------

250

SG

TG

IML

1000



REF. 790

- Round-shaped pencil cup.
- Opaque colours.

COLOURS:

790 GREY	790 GREEN	790 BLUE
790 RED	790 BLACK	

250

SG

TG



REF. CE530GM

- Magnetized pencil pot, with powerful magnet to use on metal surfaces (white boards, cabinets, etc.)
- Modern design with 2 compartments.
- Made of high impact polystyrene.

COLOURS:

CE530GM WHITE	CE530GM KIWI GREEN
---------------	--------------------

Desktop Organisers.

- Desktop organisers with several compartments for organising all your office material and having it at hand whenever you need it!

250 SG TG



1000

REF. 791

- 4-compartment organiser: 2 for pens, pencils, etc. and 2 for small accessories.
- Opaque colours.

COLOURS:

791 GREY 791 GREEN
791 BLUE 791 RED
791 BLACK



1000

REF. 792

- 4-compartment desktop organiser for small-sized office material: clips, erasers, etc.
- Opaque colours.

COLOURS:

792 GREY 792 GREEN
792 BLUE 792 RED
792 BLACK



3000

REF. 828 TP

- 6-compartment desktop organiser : one for calendar refill (included) + 4 for rulers, pens, pencils...+ 1 for business cards.
- Transparent colour.

COLOURS:

828 TP CRYSTAL

Desktop Memo Holders.

- Desktop Memo Pad Holder to have at hand when you need to quickly jot down information.

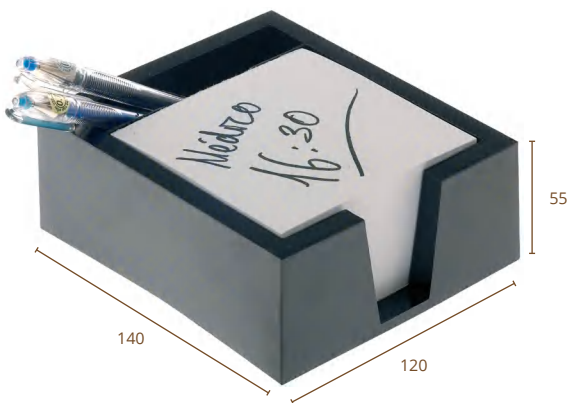

REF. 780

- Desktop square memo pad holder for note pad 100 x 100 mm
- Pad included. Rear part for pens.
- Opaque colours.

250 SG TG IML 1000

COLOURS:

780 GREY 780 GREEN 780 BLUE
780 RED 780 BLACK

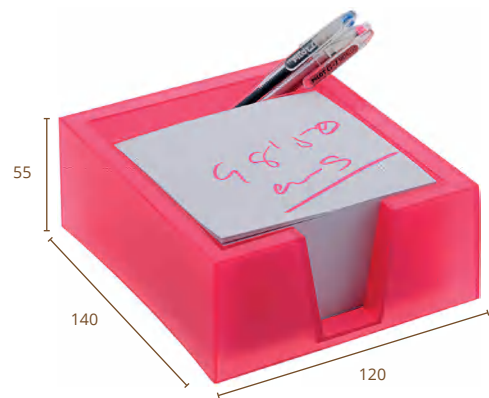

REF. 780 TL

- Desktop square memo pad holder for note pad 100 x 100 mm
- Pad included. Rear part for pens.
- Translucent colours.

250 SG TG IML 1000

COLOURS:

780 TL BLUE 780 TL RED 780 TL ORANGE
780 TL CRYSTAL 780 TL GREEN 780 TL SEA BLUE
780 TL MAUVE 780 TL KIWI GREEN 780 TL FUCHSIA

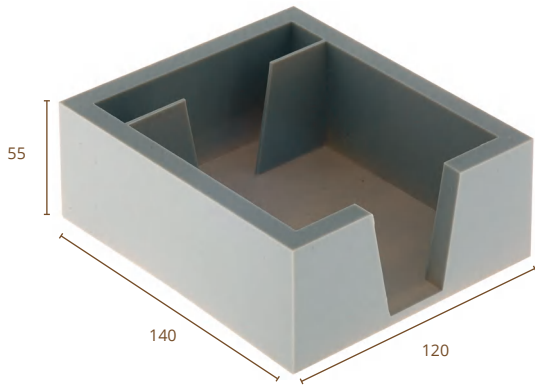

REF. 781

- Desktop square memo pad holder for note pad 100 x 100 mm
- Pad not included. Rear part for pens.
- Opaque colours.



COLOURS:

- | | | |
|----------|-----------|----------|
| 781 GREY | 781 GREEN | 781 BLUE |
| 781 RED | 781 BLACK | |

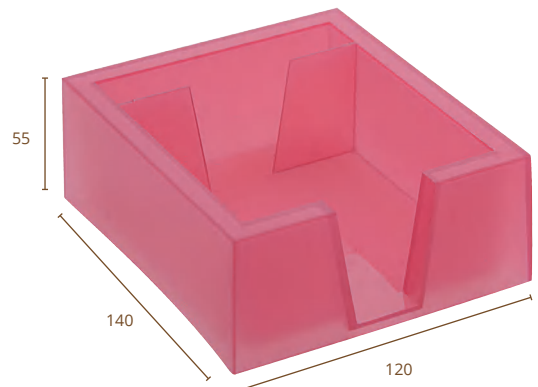

REF. 781 TL

- Desktop square memo pad holder for note pad 100 x 100 mm
- Pad not included. Rear part for pens.
- Translucent colours.



COLOURS:

- | | | |
|----------------|-------------------|-----------------|
| 781 TL BLUE | 781 TL RED | 781 TL ORANGE |
| 781 TL CRYSTAL | 781 TL GREEN | 781 TL SEA BLUE |
| 781 TL MAUVE | 781 TL KIWI GREEN | 781 TL FUCHSIA |

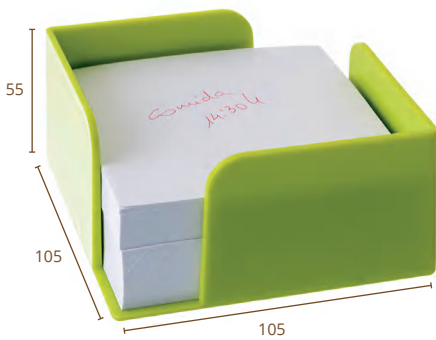

REF. 800

- Desktop square memo pad holder for note pad 100 x 100 mm
- Pad included.
- Opaque colours.

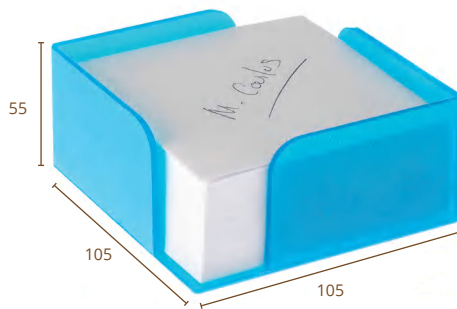

REF. 800 TL

- Desktop square memo pad holder for note pad 100 x 100 mm
- Pad included.
- Translucent colours.

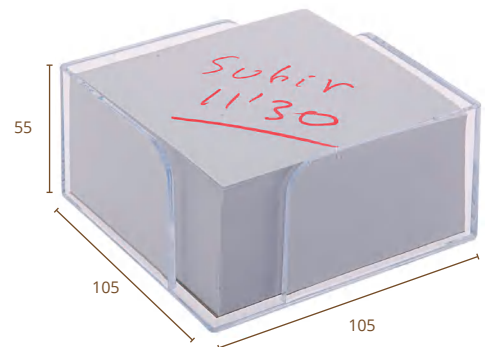

REF. 800 TP

- Desktop square memo pad holder for note pad 100 x 100 mm
- Pad included.
- Transparent colours.



COLOURS:

- | | |
|----------------|--------------|
| 800 GREY | 800 GREEN |
| 800 BLUE | 800 RED |
| 800 BLACK | 800 FUCHSIA |
| 800 MAUVE | 800 SEA BLUE |
| 800 KIWI GREEN | 800 WHITE |

COLOURS:

- | | |
|----------------|-------------------|
| 800 TL BLUE | 800 TL RED |
| 800 TL ORANGE | 800 TL CRYSTAL |
| 800 TL GREEN | 800 TL SEA BLUE |
| 800 TL MAUVE | 800 TL KIWI GREEN |
| 800 TL FUCHSIA | |

COLOURS:

- | | |
|----------------|---------------|
| 800 TP CRYSTAL | 800 TP SMOKED |
|----------------|---------------|



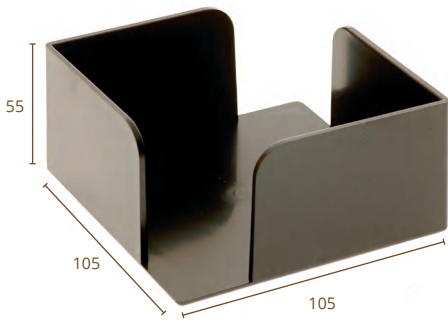

REF. 801

- Desktop square memo pad holder for note pad 100 x 100 mm
- Pad not included.
- Opaque colours.

COLOURS:

- | | |
|----------------|--------------|
| 801 GREY | 801 GREEN |
| 801 BLUE | 801 RED |
| 801 BLACK | 801 FUCHSIA |
| 801 MAUVE | 801 SEA BLUE |
| 801 KIWI GREEN | 801 WHITE |

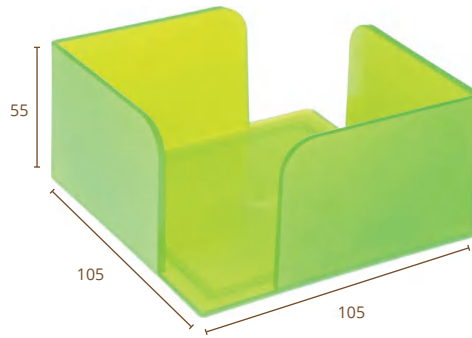

REF. 801 TL

- Desktop square memo pad holder for note pad 100 x 100 mm
- Pad not included.
- Translucent colours.

COLOURS:

- | | |
|---------------|-------------------|
| 801 TL BLUE | 801 TL FUCHSIA |
| 801 TL ORANGE | 801 TL RED |
| 801 TL GREEN | 801 TL SEA BLUE |
| 801 TL MAUVE | 801 TL KIWI GREEN |

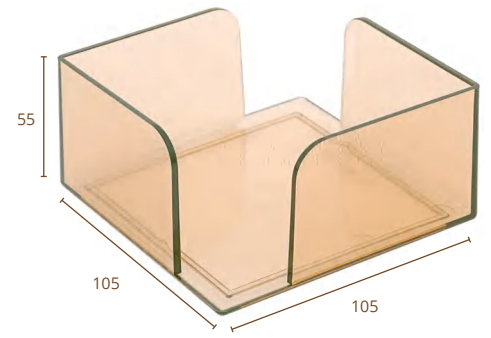

REF. 801 TP

- Desktop square memo pad holder for note pad 100 x 100 mm
- Pad not included.
- Transparent colours.

COLOURS:

- | | |
|----------------|---------------|
| 801 TP CRYSTAL | 801 TP SMOKED |
|----------------|---------------|



☒☒☒ **Coin Banks.**

- Coin banks with key injected in high gloss and transparent polystyrene with metallic lock at the base, injected in zamak.
- Includes key.



REF. 832 TP

- Coin bank with key.
- Transparent colour.

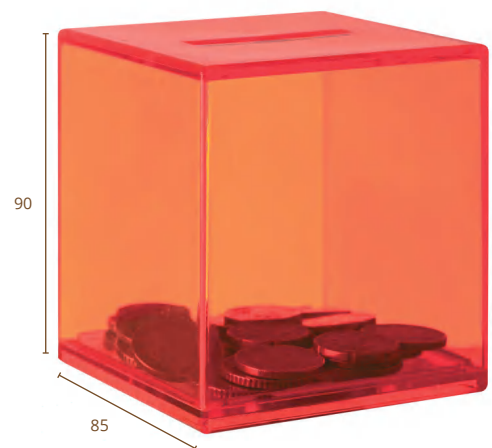

REF. 832 TL

- Coin bank with key.
- Translucent orange-coloured.

GENERAL CONDITIONS

Finishings

We have included reference numbers for each of our products in this catalogue in order to identify the different finishings (transparent, translucent or metallic).

In addition, each colour has its own reference number as we explain below:

TP Transparent
TL Translucent
MT Metallic

6101
REFERENCE

VE
COLOR

TP
FINISHING

Of Spanish Manufacture

The Display Cases marked with the "PREMIUM" icon are manufactured in Spain and are of high quality and resistance.

PREMIUM

We can manufacture any type of display case you need. If you don't find the model you are looking for in this catalogue please contact us!

Measurements

All the measurements are expressed in millimetres and generally using as a reference (depth x width x height).

In cylindrical products, we take into account diameter by height and for flat products, width by height.

Colours

The nomenclature of our range of colours is the following:

Steel	AC	Burgundy	BU
Mauve	ML	Red	RJ
Aluminum	AL	Crystal	CS
Yellow	AM	Assortment	SU
Ivory	MF	Chrome	CM
Anthracite	AN	Green	VE
Brown	MR	Fuchsia	FC
Blue	AZ	Kiwi Green	KW
Orange	NA	Smoked	FM
Graphite	GF	Sea Blue	LG
Beige	BE	Black	NE
Nickel	NI	Grey	GS
Silver	PT	White	BL

PRODUCT PERSONALISATION

Our products can be marked with your company logo using different personalisation methods such as serigraphy, thermal printing or IML.

Customisable products

We have identified those products that can be personalised using a series of icons.

In each one we indicate the minimum amount required in order to proceed with the option chosen by our client.



CUSTOMISABLE PRODUCT

Will indicate the minimum amount required to be able to personalize it.



SPECIAL COLOURS

Will indicate the minimum amount required to be able to manufacture this product in special colours referenced.



PERSONALISATION METHOD

SG: Serigraphy
TI: Thermal Printing
TG: Tampon Printing
IML: In-Mould-Labeling



SPECIAL MEASUREMENTS

Will indicate the minimum amount required to be able to manufacture this product with special measurements.

archivo[®]
2000





Lg Alvedro, s/n
Culleredo - 15180, A Coruña (Spain)

+34 981 66 00 03 / 05

Fax: +34 981 66 55 61

Apartado 1118
15018, A Coruña (Spain)

www.archivo2000.com

administracion@archivo2000.es